

1006

Series electric strike

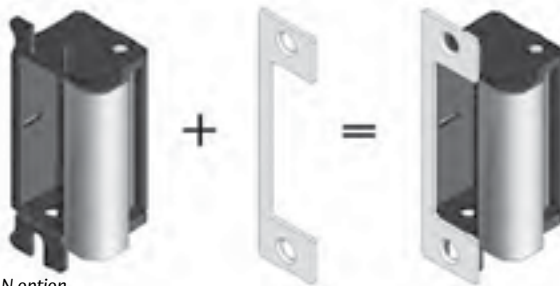

shown with J option



shown with N option

We offer several types of faceplate options to accommodate your application. Faceplate options sold separately (see pages 5-10).



ANSI A250.13-2003
windstorm resistant



fire rated



UL 1034
burglary listed



field selectable
(12 or 24VDC)



grade 1

The strongest, most versatile electric strike available

The 1006 series is the strongest and most versatile electric strike available. It meets or exceeds every standard developed for electric strikes. With 27 faceplate options, the 1006 can accommodate virtually every type of lockset on the market. Recently updated, the 1006 features a sleek new keeper and 100% stainless steel cast case. Tested to exceed 3,000 lbs. of static strength, 350 ft. lbs. of dynamic strength and factory tested to exceed 1,000,000 cycles of operation, the 1006 is in a class of its own.

Specifications

- UL 10C fire-rated, 3 hour single door (fail secure only)
- UL 10C fire-rated, 1-1/2 hour double door (fail secure only)
- ANSI A250.13-2003 windstorm listed
- UL 1034, burglary-resistant listed
- ANSI/BHMA A156.31, Grade 1
- NFPA-252 fire door conformant
- ASTM-E152 fire door conformant
- MEA New York City accepted
- Florida Building Code approved
- Patents # 6021038 & 6595564

Frame Application

- Metal
- Wood

Electrical

- .45 Amps @ 12VDC continuous duty
- .25 Amps @ 24VDC continuous duty

1006 series

cylindrical locksets



mortise locks without deadbolts



mortise locks with deadbolts



specialty locksets



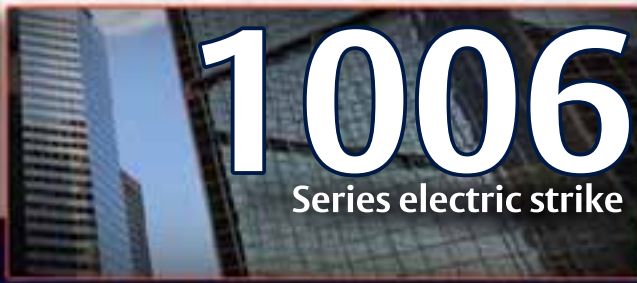

1006

Series electric strike

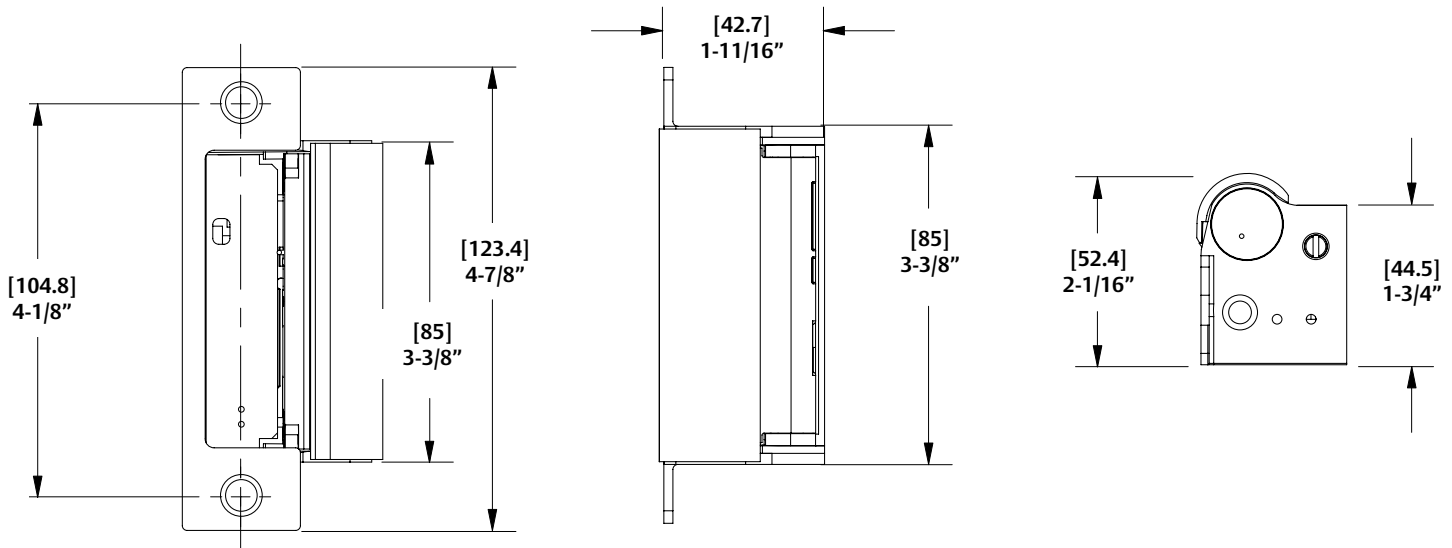

1006 series

diagram shown with N option

Standard Features

- Stainless steel construction
- Tamper resistant
- Static strength 3,070 lbs. (fail secure)
- Dynamic strength 350 ft-lbs. (fail secure)
- Endurance 1,000,000 cycles
- Fail secure (standard)
- Dual voltage 12VDC or 24VDC continuous duty
- Non-handed
- Internally mounted solenoid
- Accommodates up to 1" deadbolt
- Plug-in connector
- Full keeper shims
- Trim enhancer
- Five year limited warranty

Optional Features

- Fail Safe
- LBM - Latchbolt monitor
- LBSM - Latchbolt strike monitor
- 27 interchangeable faceplate options

Monitor Switches may not work with all faceplate options (see pages 5-10)

Accessories

- 1000-102 Rain guard
- 1006-103 DFM Full keeper shims
- 1000-104 Lip extension trim adapter
- 1006-105 DFM Trim enhancer BLK (goof plate)
- 1006-109 DFM Trim adapter
- 1000-110 Replacement strike plate
- 1000-130 KD filler plate
- 154 - MTK Metal template kit
- 2001M - Plug-in bridge rectifier
- 2004M - ElectroLynx[®] adapter
- 2005M - SMART Pac II[™]
- 2006M - Plug-in buzzer

Finishes

- 630 - Satin stainless steel finish
- 605 - Bright brass finish
- 606 - Satin brass finish
- 612 - Satin bronze finish
- 613 - Bronze toned finish
- 629 - Bright stainless steel finish
- BLK - Black finish

1006

Series faceplate options



J Option

Operation: After releasing the latchbolt, the keeper returns to the locked position.



4-7/8" x 1-1/4"

J

For use with:

Cylindrical locksets up to 3/4" throw and all locksets with center-lined bolts.
ANSI/BHMA Numbers: #E09321, #E09322, #E09323

type of lock released



specialty E Option

Operation: After releasing the latchbolt/deadbolt, the keeper is held open and recaptures the bolt when the door is closed. Not LBM/LBSM compatible.

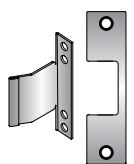

4-7/8" x 1-1/4"

E

For use with:

Corbin/Russwin Security Bolt, Weiserbolt, and normally extended 1" tubular deadbolts.
ANSI/BHMA Numbers: #E09391, #E09392, #E09393

type of lock released



K, KD, KM Options

Operation: After releasing the latchbolt, the keeper returns to the locked position.



K

For use with:

Mortise locksets with a deadlatch positioned **above** the latchbolt.

Compatible Locksets:

Baldwin, Marks, PDQ, Others

ANSI/BHMA Numbers: #E09321, #E09322, #E09323

type of lock released



KD

For use with:

Mortise locksets with a deadlatch positioned **above** the latchbolt.

Compatible Locksets:

Jackson, Sargent (7700 & 8100), Schlage, Yale (8700)

ANSI/BHMA Numbers: #E09321, #E09322, #E09323

type of lock released



KM

For use with:

Mortise locksets with a deadlatch positioned **below** the latchbolt.

Compatible Locksets:

Accurate, Arrow, Best*, Corbin/Russwin, Falcon (1992 M Series), Sargent (7800, 8200 & 9200 series), Yale (8800)

*For Best 45H & 47H deadlatch below, and Best 34H - 37H deadlatch above.

ANSI/BHMA Numbers: #E09321, #E09322, #E09323

type of lock released



4-7/8" x 1-1/4"



1006

Series faceplate options



N, ND, NM Options

Operation: The deadbolt is retracted during traffic hours. The latchbolt is released by the keeper. The keeper returns to the locked position. If the deadbolt is extended, the keeper will not recapture it.

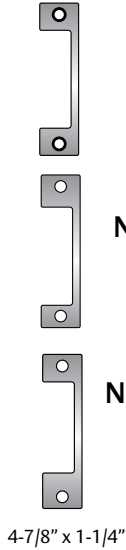

N For use with:
Mortise locksets where the deadbolt is used for night-latch function only.
Compatible Locksets:
Accurate, Arrow, Baldwin, Marks, Omnia, PDQ, Others
ANSI/BHMA Numbers: #E09391, #E09392, #E09393, #E09331, #E09332, #E09333

type of lock released



ND For use with:
Mortise locksets where the deadbolt is used for night-latch function only.
Compatible Locksets:
Sargent (7700 & 8100 series), Schlage, Yale (8700)
ANSI/BHMA Numbers: #E09391, #E09392, #E09393, #E09331, #E09332, #E09333



NM For use with:
Mortise locksets with a deadlatch positioned **below** the latchbolt and where the deadbolt is used for night-latch function only.
Compatible Locksets:
Best (45H & 47H, and 34H-37H), Corbin/Russwin, Falcon, Sargent (7800, 8200 & 9200 series)
ANSI/BHMA Numbers: #E09391, #E09392, #E09393, #E09331, #E09332, #E09333



1006 faceplates



A, AD, AM Options

Operation: Latchbolt and deadbolt are released by a single keeper. The keeper is held open to recapture the latchbolt and the deadbolt when the door is closed. Not LBM/LBSM compatible.

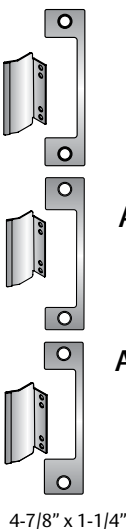

A For use with:
Mortise locksets with a normally extended 1" deadbolt without a deadlatch.
Compatible Locksets:
Arrow, Baldwin, Marks, Omnia, PDQ, Others
ANSI/BHMA Numbers: #E09391, #E09392, #E09393, #E09331, #E09332, #E09333

type of lock released



AD For use with:
Mortise locksets with a normally extended 1" deadbolt without a deadlatch.
Compatible Locksets:
Sargent (7700 & 8100 series), Schlage, Yale (8700)
ANSI/BHMA Numbers: #E09391, #E09392, #E09393, #E09331, #E09332, #E09333

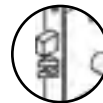

AM For use with:
Mortise locksets with a normally extended 1" deadbolt and a deadlatch positioned **below** the latchbolt.
Compatible Locksets:
Accurate, Best (45H & 47H, and 34H-37H), Corbin/Russwin, Falcon, Sargent (7800, 8200, & 9200 series), Yale (8800)
ANSI/BHMA Numbers: #E09391, #E09392, #E09393, #E09331, #E09332, #E09333



1006

Series faceplate options



T, TD Options

Operation: Latchbolt and deadbolt are released by a single keeper. The keeper is held open to recapture the latchbolt and deadbolt, and the deadlatch is engaged when the door is closed. Not LBM/LBSM compatible.

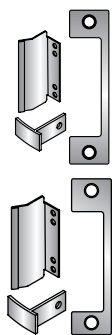

4-7/8" x 1-1/4"

- | | | type of lock released |
|-----------|---|-----------------------|
| T | <p>For use with:
Mortise locksets with a normally extended 1" deadbolt and a center-lined deadlatch.</p> <p>Compatible Locksets:
Accurate, Arrow, Baldwin, Marks, Omnia, PDQ, Others
ANSI/BHMA Numbers: #E09391, #E09392, #E09393, #E09331, #E09332, #E09333</p> | |
| TD | <p>For use with:
Mortise locksets with a normally extended 1" deadbolt and a center-lined deadlatch.</p> <p>Compatible Locksets:
Sargent (7700 & 8100 series), Schlage, Yale (8700)
ANSI/BHMA Numbers: #E09391, #E09392, #E09393, #E09331, #E09332, #E09333</p> | |



H, HD, HM Options

Operation: Lockout feature - the electric strike will not release when the deadbolt is extended. The deadbolt is retracted during traffic hours. The latchbolt is released by the keeper. The keeper returns to the locked position. Not LBM/LBSM compatible.

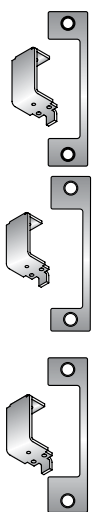

4-7/8" x 1-1/4"

- | | | type of lock released |
|-----------|--|-----------------------|
| H | <p>For use with:
Mortise locksets with a 1" deadbolt without a deadlatch. Strike will not release when deadbolt is extended.</p> <p>Compatible Locksets:
Arrow, Baldwin, Marks, Omnia, PDQ, Others
ANSI/BHMA Numbers: #E09391, #E09392, #E09393, #E09331, #E09332, #E09333</p> | |
| HD | <p>For use with:
Mortise locksets with a 1" deadbolt without a deadlatch. Strike will not release when deadbolt is extended.</p> <p>Compatible Locksets:
Sargent (7700 & 8100 series), Schlage, Yale (8700)
ANSI/BHMA Numbers: #E09391, #E09392, #E09393, #E09331, #E09332, #E09333</p> | |
| HM | <p>For use with:
Mortise locksets with a 1" deadbolt with a deadlatch positioned below the latchbolt. Strike will not release when deadbolt is extended.</p> <p>Compatible Locksets:
Accurate, Best (45H & 47H, and 34H-37H), Corbin/Russwin, Falcon, Sargent (7800, 8200, & 9200 series), Yale (8800)
ANSI/BHMA Numbers: #E09391, #E09392, #E09393, #E09331, #E09332, #E09333</p> | |



1006

Series faceplate options



HT, HTD Option

Operation: Lockout feature - the electric strike will not release when the deadbolt is extended. The deadbolt is retracted during traffic hours. The latchbolt is released by the keeper. The keeper returns to the locked position. * For the ASSA model 504, the top latchbolt is released by the keeper. The keeper returns to the locked position. Not LBM/LBSM compatible.

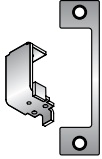

4-7/8" x 1-1/4"

HT

For use with:

ASSA model 504 mortise lockset with two latchbolts and a center deadlatch. Deadlatch or mortise locksets with a 1" deadbolt and a center-lined deadlatch. Strike will not release when deadbolt is extended.

Compatible Locksets:

ASSA

ANSI/BHMA Numbers: #E09391, #E09392, #E09393, #E09331, #E09332, #E09333

type of lock released

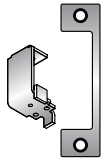

4-7/8" x 1-1/4"

HTD

For use with:

Mortise locksets with a 1" deadbolt and a center-lined deadlatch. Strike will not release when deadbolt is extended.

Compatible Locksets:

Sargent (7700 & 8100 series), Schlage, Yale (8700)

ANSI/BHMA Numbers: #E09391, #E09392, #E09393, #E09331, #E09332, #E09333

type of lock released



R Option

Operation: The hookbolt is released by the keeper. The keeper is held open to recapture the hookbolt when the door is closed. Not LBM/LBSM compatible.

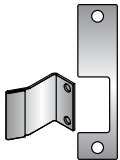

4-7/8" x 1-1/4"

R

For use with:

A hookbolt up to 1" throw.

Compatible Locksets:

Adams Rite, Others

ANSI/BHMA Numbers: #E09391, #E09392, #E09393, #E09331, #E09332, #E09333

type of lock released



Z Option

Operation: After releasing the latchbolt, the keeper returns to the locked position.



4-7/8" x 1-1/4"

Z

For use with:

Unit and mono locks.

Compatible Locksets:

Unican, Sargent, Corbin-Russwin

ANSI/BHMA Numbers: #E09321, #E09322, #E09323

type of lock released



1006 faceplates

1006

Series faceplate options



J-2 Option

Operation: After releasing the latchbolt, the keeper returns to the locked position.



9" x 1-3/8"

J-2 For use with:
Cylindrical locksets with up to a 3/4" throw, in wood frame applications.
ANSI/BHMA Numbers: #E09321, #E09322, #E09323

type of lock released



K-2 Option

Operation: After releasing the latchbolt, the keeper returns to the locked position.



9" x 1-3/8"

K-2 For use with:
Mortise locksets with a deadlatch positioned **above** the latchbolt, in wood frame applications.
Compatible Locksets:
Baldwin, Marks, PDQ, Others
ANSI/BHMA Numbers: #E09321, #E09322, #E09323

type of lock released



KM-2 Option

Operation: After releasing the latchbolt, the keeper returns to the locked position.



9" x 1-3/8"

KM-2 For use with:
Mortise locksets with a deadlatch positioned **below** the latchbolt, in wood frame applications.
Compatible Locksets:
Accurate, Arrow, Best*, Corbin/Russwin, Falcon (1992 M Series), Sargent (7800, 8200 & 9200 series), Yale (8800)
*For Best 45H & 47H deadlatch below, and Best 34H - 37H deadlatch above.
ANSI/BHMA Numbers: #E09321, #E09322, #E09323

type of lock released





1006

Series faceplate options



N-2 Option



9" x 1-3/8"

Operation: The deadbolt is retracted during traffic hours. The latchbolt is released by the keeper. The keeper returns to the locked position. If the deadbolt is extended the keeper will not recapture it.

N-2

For use with:

Mortise locksets where the deadbolt is used for night-latch function only, in wood frame applications.

Compatible Locksets:

Accurate, Arrow, Baldwin, Marks, Omnia, PDQ, Schlage, Yale (8700), Others
ANSI/BHMA Numbers: #E09391, #E09392, #E09393, #E09331, #E09332, #E09333

type of lock released



T-2 Option

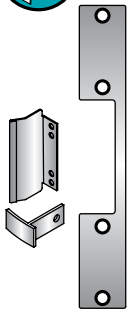

9" x 1-3/8"

Operation: Latchbolt and deadbolt are released by a single keeper. The keeper is held open to recapture the latchbolt and deadbolt, and the deadlatch is engaged when the door is closed. Not LBM/LBSM compatible.

T-2

For use with:

Mortise locksets with a normally extended 1" deadbolt and a center-lined deadlatch, in wood frame applications.

Compatible Locksets:

Accurate, Arrow, Baldwin, Marks, Omnia, PDQ, Schlage, Yale (8700), Others
ANSI/BHMA Numbers: #E09391, #E09392, #E09393, #E09331, #E09332, #E09333

type of lock released



A-2 Option

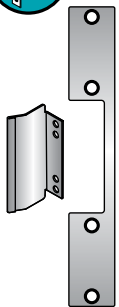

9" x 1-3/8"

Operation: Latchbolt and deadbolt are released by a single keeper. The keeper is held open to recapture the latchbolt and deadbolt. Not LBM/LBSM compatible.

A-2

For use with:

Mortise locksets with a normally extended 1" deadbolt without a deadlatch, in wood frame applications.

Compatible Locksets:

Accurate, Arrow, Baldwin, Marks, Omnia, PDQ, Schlage, Yale, Others
ANSI/BHMA Numbers: #E09391, #E09392, #E09393, #E09331, #E09332, #E09333

type of lock released

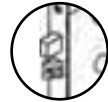

H-2 Option

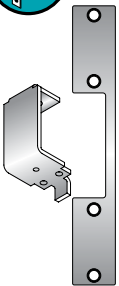

9" x 1-3/8"

Operation: Lockout feature- the electric strike will not release when deadbolt is extended. The deadbolt is retracted during traffic hours. The latchbolt is released by the keeper. The keeper returns to the locked position. Not LBM/LBSM compatible.

H-2

For use with:

Mortise locksets with a 1" deadbolt without a deadlatch, in wood frame applications. Strike will not release when deadbolt is extended.

Compatible Locksets:

Accurate, Arrow, Baldwin, Marks, Omnia, PDQ, Schlage, Yale (8700)
ANSI/BHMA Numbers: #E09391, #E09392, #E09393, #E09331, #E09332, #E09333

type of lock released



1006 faceplates